

Datum 08.11.2016 Maßstab 1:1

Zeichnungsnummer
G-MGW080-2Z

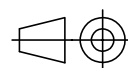

GRIP
GRIP GmbH Handhabungstechnik

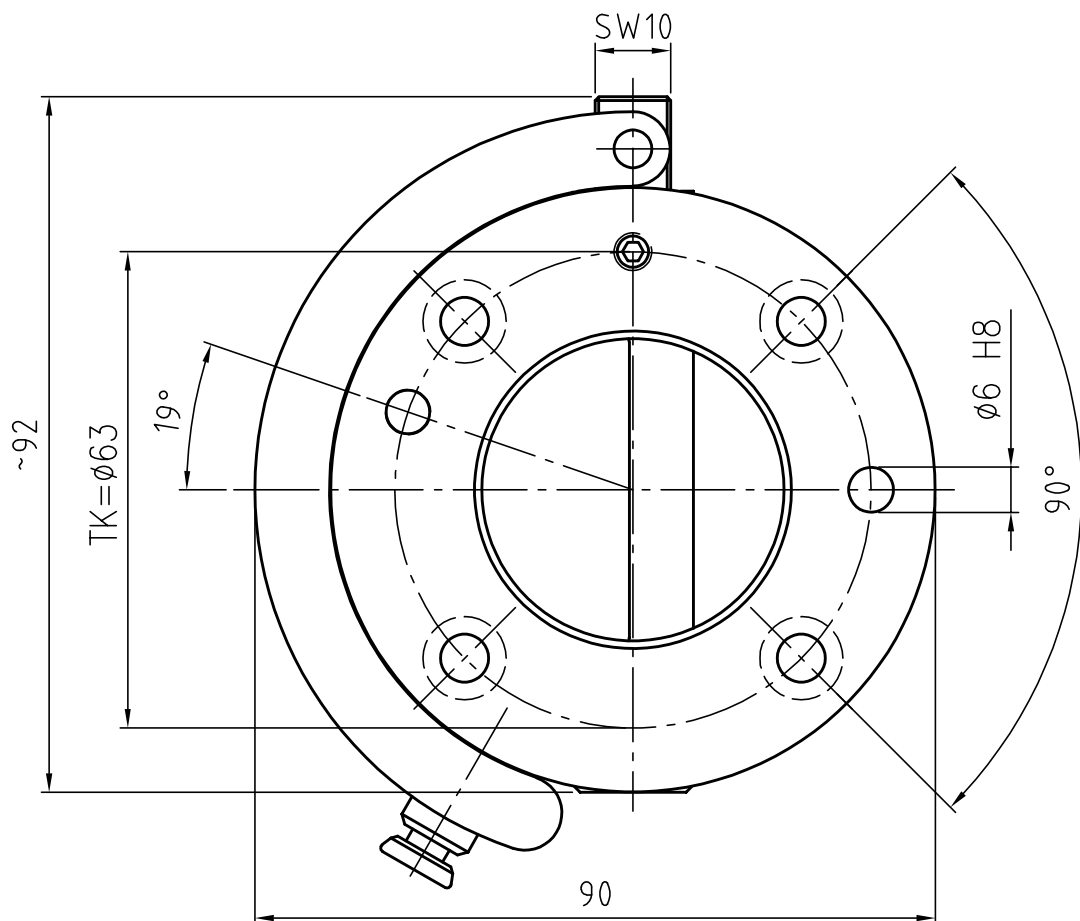
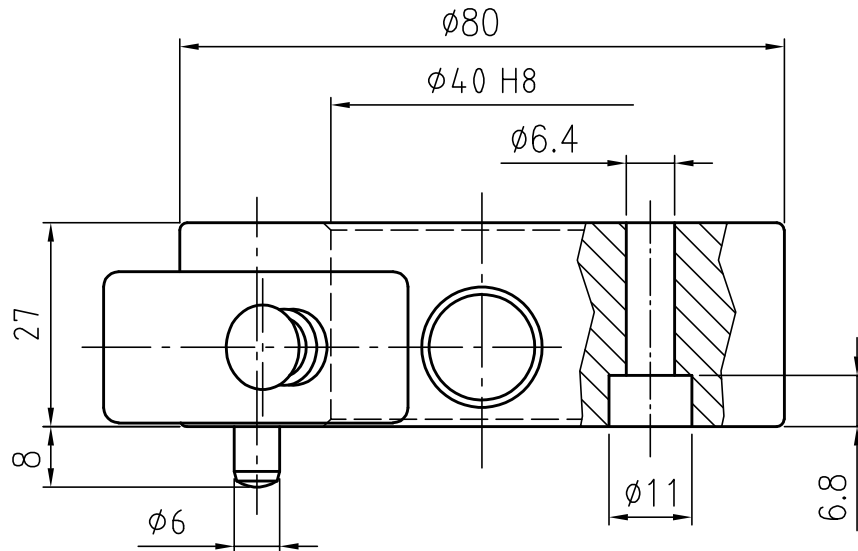

Grundmaterial	Bestellnummer Oberteil
Al. eloxiert	G-MGW080-20
Stahl	G-MGW080-20-S
St. nitriert	G-MGW080-20-N

Datum 08.11.2016

Maßstab 1:1

Zeichnungsnummer

G-MGW080-20

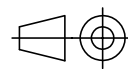

GRIP

GRIP GmbH Handhabungstechnik

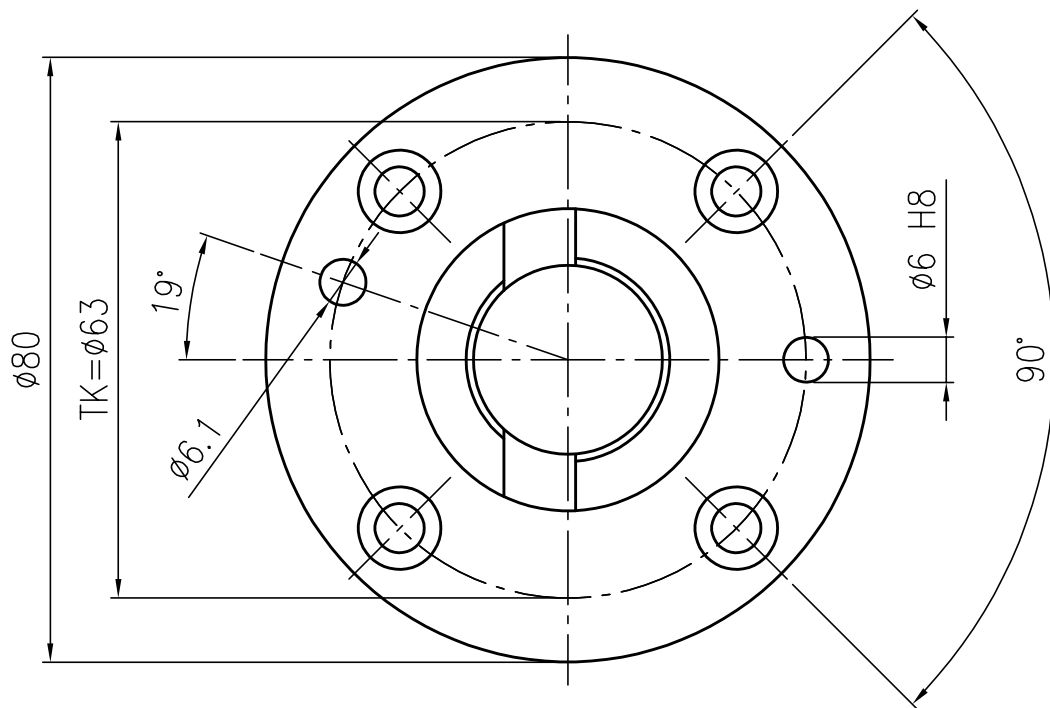
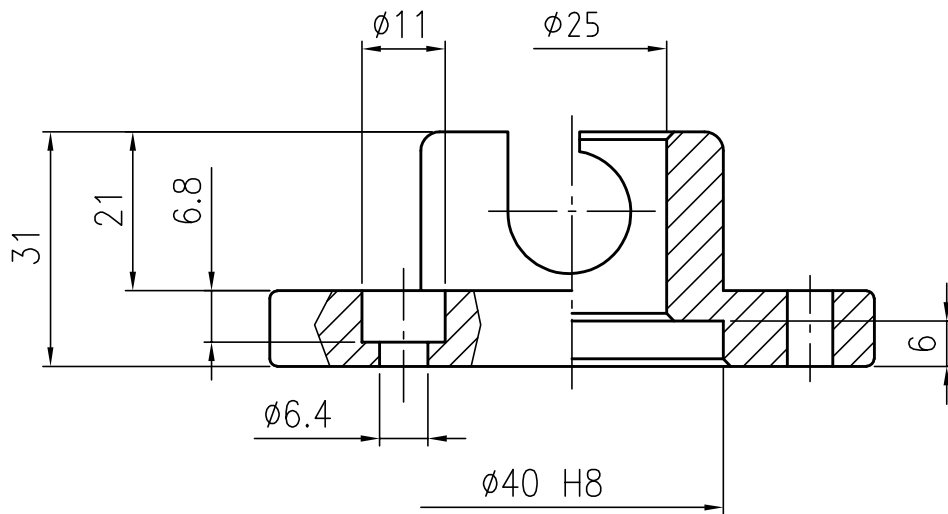

Grundmaterial	Bestellnummer Unterteil
Al. eloxiert	G-MGW080-2U
Stahl	G-MGW080-2U-S
St. nitriert	G-MGW080-2U-N

Datum 08.11.2016

Maßstab 1:1

Zeichnungsnummer

G-MGW080-2U

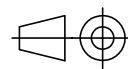

GRIP

GRIP GmbH Handhabungstechnik

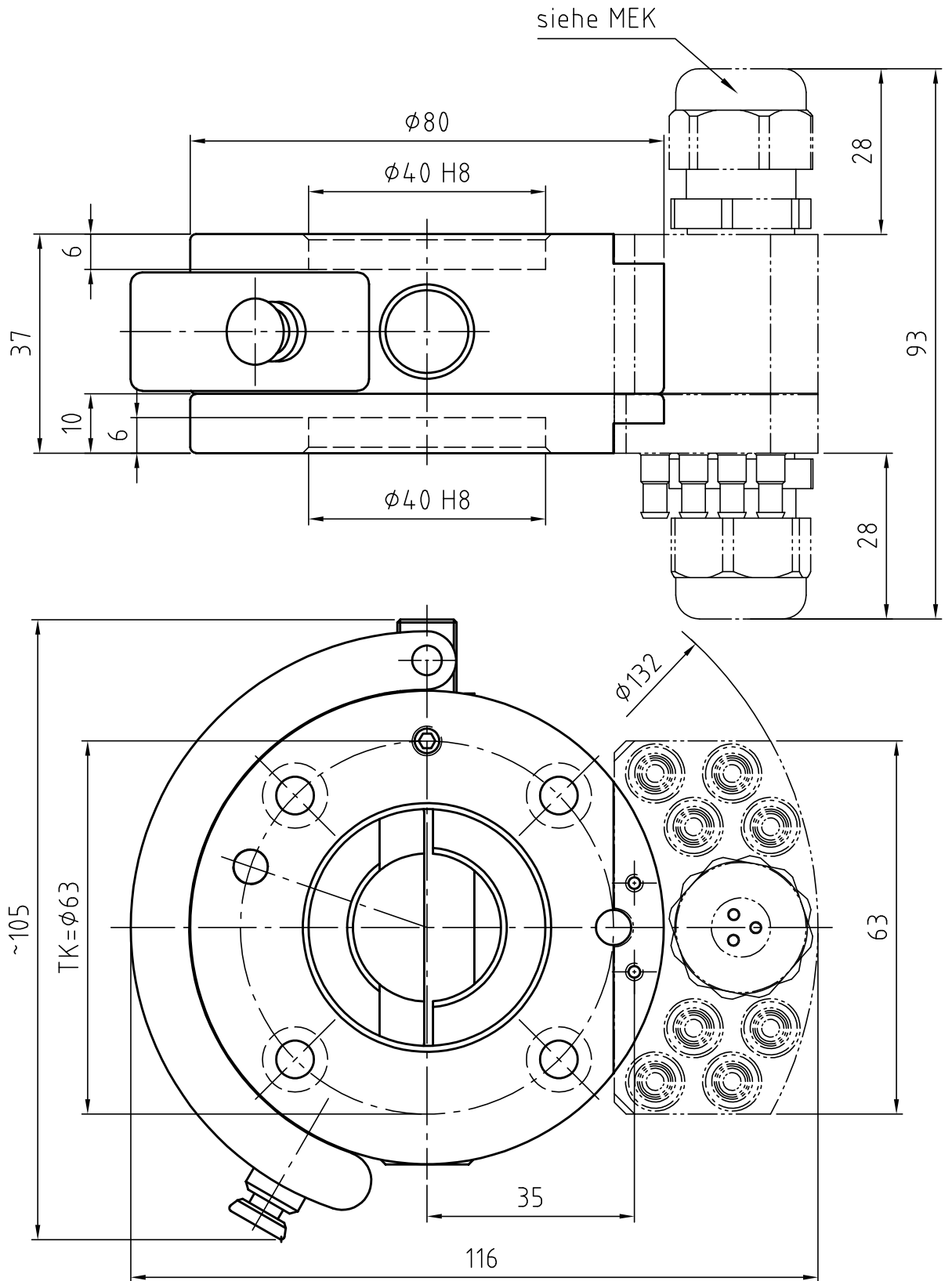

Datum 08.11.2016

Maßstab 1:1

Zeichnungsnummer

G-MGW080-2ZE

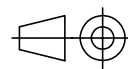

GRIP

GRIP GmbH Handhabungstechnik

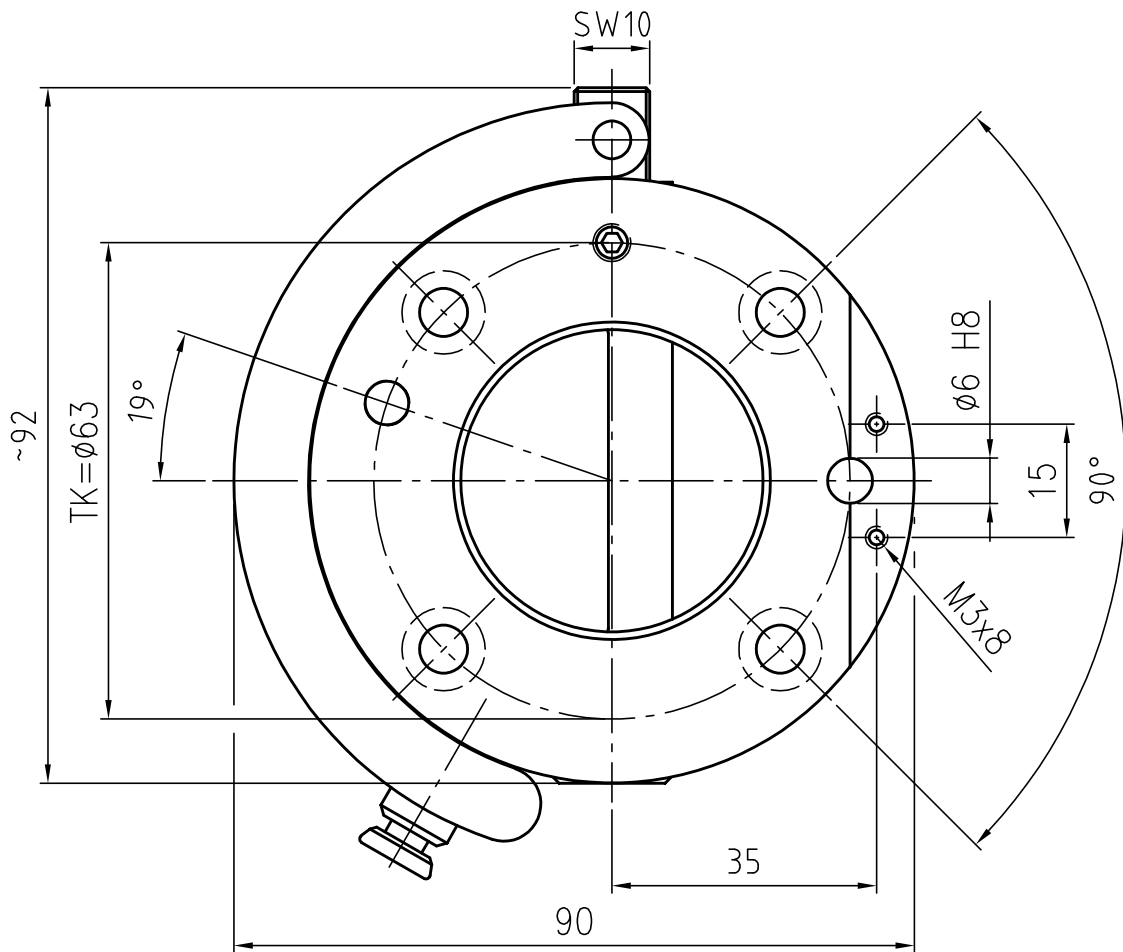
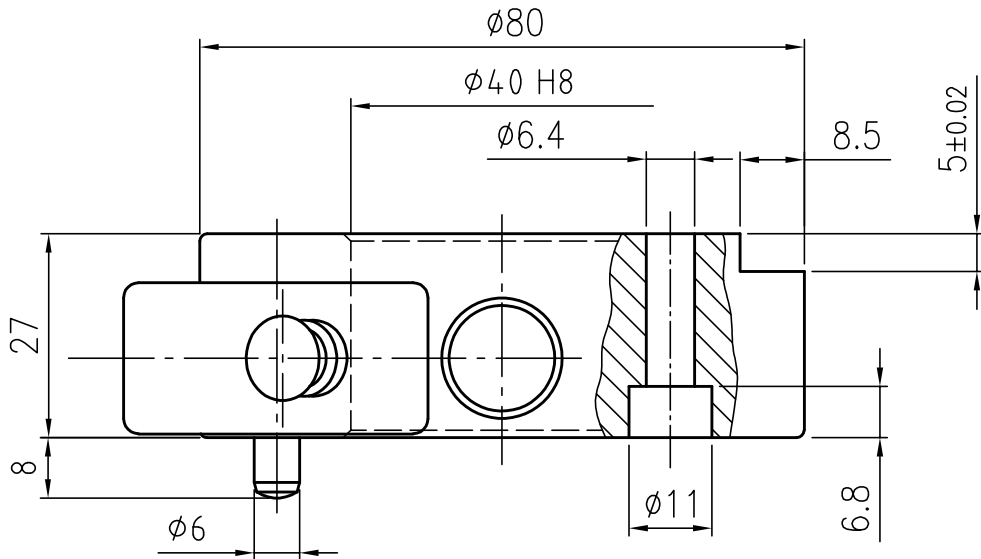

Grundmaterial	Bestellnummer Oberteil
Al. eloxiert	G-MGW080-20E
Stahl	G-MGW080-20ES
St. nitriert	G-MGW080-20EN

Datum 08.11.2016

Maßstab 1:1

Zeichnungsnummer

G-MGW080-20E

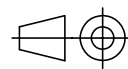

GRIP

GRIP GmbH Handhabungstechnik

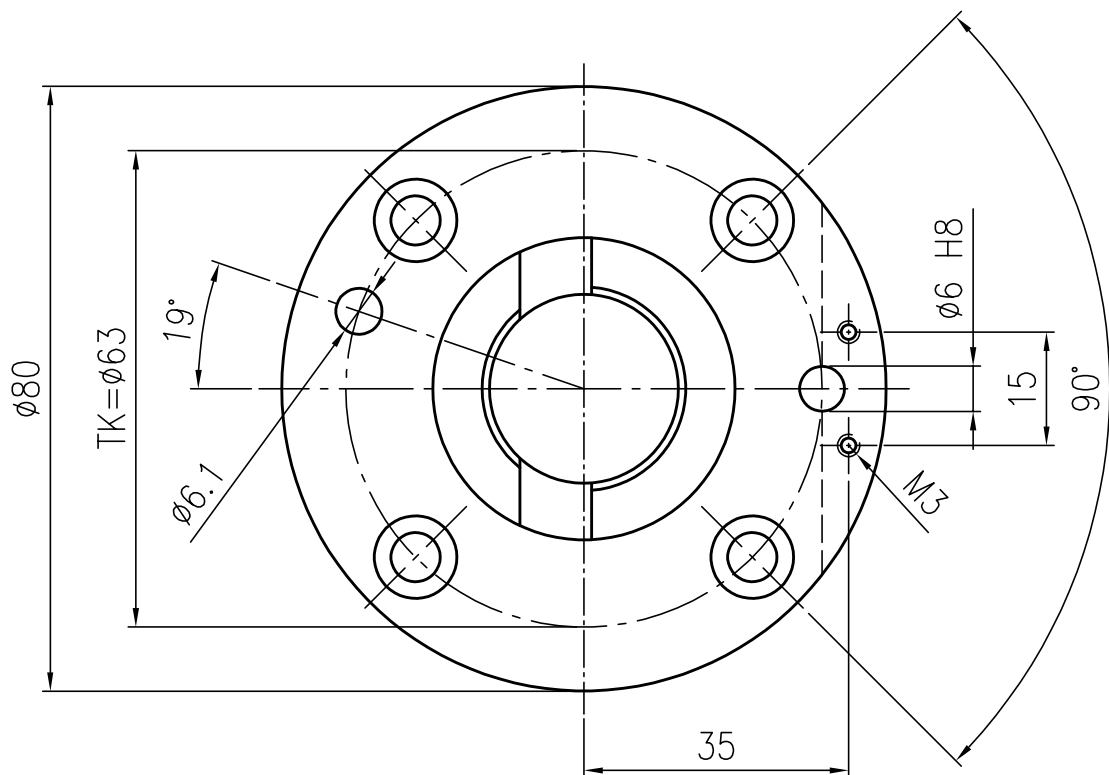
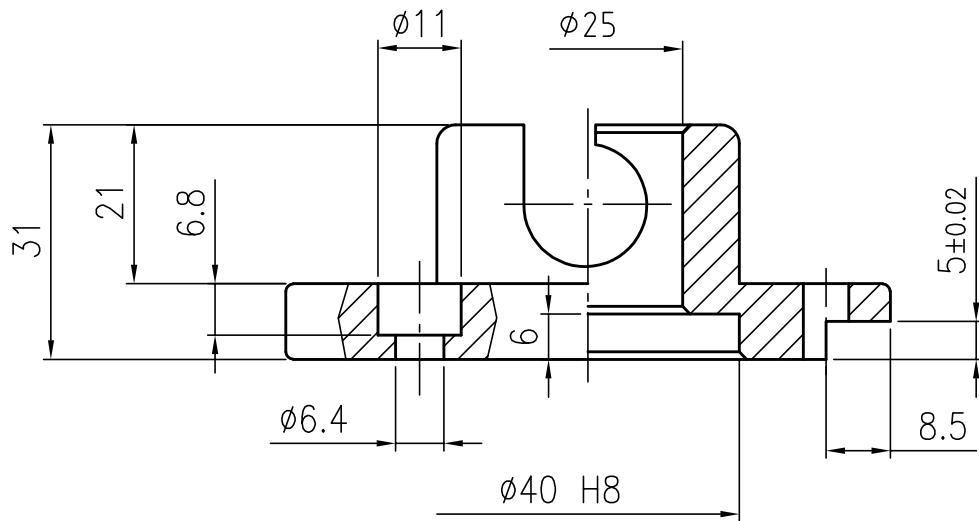

Grundmaterial	Bestellnummer Unterteil
Al. eloxiert	G-MGW080-2UE
Stahl	G-MGW080-2UES
St. nitriert	G-MGW080-2UEN

Datum 08.11.2016

Maßstab 1:1

Zeichnungsnummer

G-MGW080-2UE

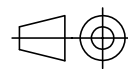

GRIP

GRIP GmbH Handhabungstechnik