

G-SEK100-P

Technical specifications



Operating mode:

The SEK upper assembly is mounted on the SHW upper assembly.
The SEK lower assembly is mounted on the SHW lower assembly accordingly. The SEK is automatically coupled by the mechanical connection of the exchange system.

Advantages:

Mechanical, electric and pneumatic connections are established simultaneously.

Withstands up to 1,000,000 changing cycles

Individual wiring and coding of the interchange parts

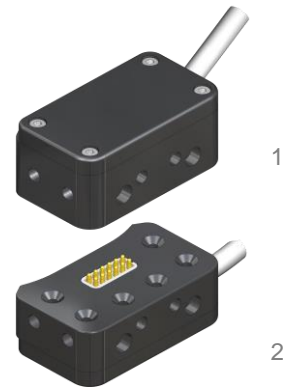

Technical specifications		SEK100-P
Basic material		Al, anod.
Compatible with		SHW 063, 080, 100 ; AC063
Adaptable to		SHW 125, 160
Width x depth x height [mm]		52 x 33,5 x 45
Signal ducts		12
Rated current I [A]		2
Rated voltage U (max. voltage) [V]		63 (120)
Contact resistance per pole R [mΩ]		20
Number P		6
Cross section A per P [mm ²]		6,16
Operating pressure p [bar]		-1 to 8
Nominal width NW [mm]		M5
Contact durability (cycles)		50.000
Mass [kg]	upper assembly	0,09
	lower assembly	0,08
Protection class (higher requirement only on request)		IP40
Operating temperature range [°C]		-30 to +120

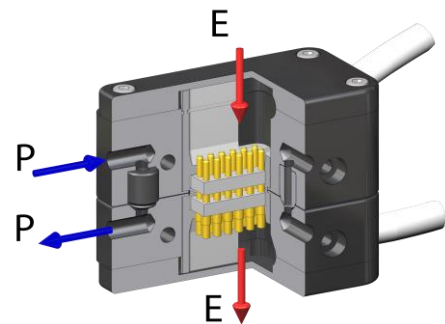

Pos.	Description
1	Upper assembly
2	Lower assembly
3.1	Upper cap
3.2	Lower cap
4	Insulation frame
5	Electric bushings
6	Electric spring pins
7	Pneumatic sealing
8	Screw
9	Mounting screw
10	Cable (optional)

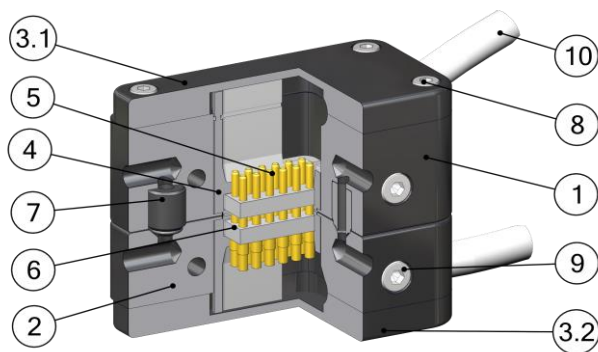

SEK energy feed-through with pneumatic ducts...

G-SEK100-O-6PM5-1FE12	upper assembly, 6 pneumatic ducts M5, electrical bushings, 12 poles
G-SEK100-O-6PM5-1FE12-2000OE	upper assembly, 6 pneumatic ducts M5, electrical bushings, 12 poles, cable L= 2000 mm, open end
G-SEK100-O-6PM5-1FE12-300-M12	upper assembly, 6 pneumatic ducts M5, electrical bushings, 12 poles, cable L= 300 mm, plug M12
G-SEK100-U-6PM5-1FE12	lower assembly, 6 pneumatic ducts M5, electrical spring pins, 12 poles
G-SEK100-U-6PM5-1FE12-2000OE	lower assembly, 6 pneumatic ducts M5, electrical spring pins, 12 poles, cable L= 2000 mm, open end
G-SEK100-U-6PM5-1FE12-300-M12	lower assembly, 6 pneumatic ducts M5, electrical spring pins, 12 poles, cable L= 300 mm, bushing M12

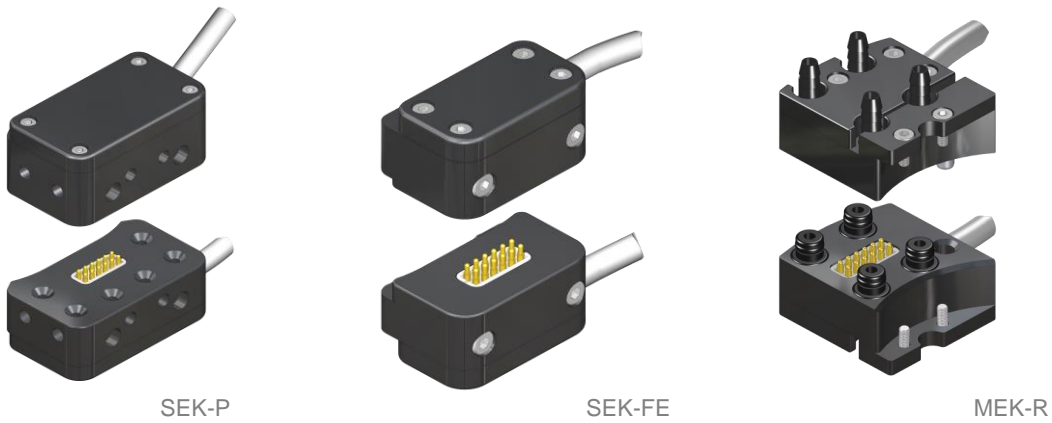

Products	Electrical connection	Cable variants
SEK-P / SEK-FE / MEK-R upper assembly	Electric strip, female (suitable for spring contacts)	M8-bushing, M12-plug, open end
SEK-P / SEK-FE / MEK-R lower assembly	Electric strip, male (including spring contacts)	M8-plug, M12-bushing, open end

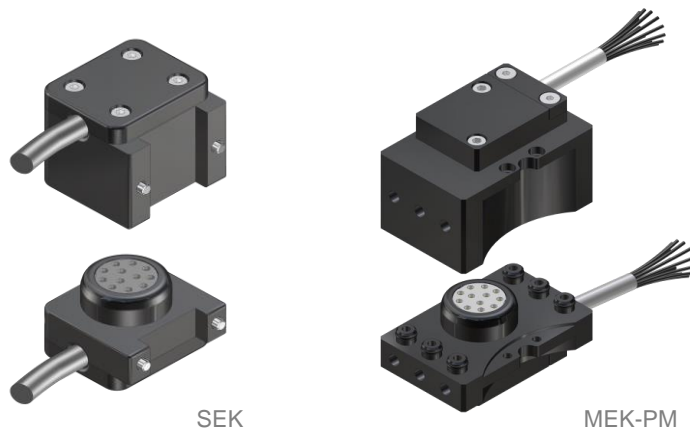

Products	Electrical connection	Cable variants
SEK / MEK-PM upper assembly	Insulating body with pin contacts	M8-bushing, M12-plug, open end
SEK / MEK-PM lower assembly	Insulating body with socket contacts	M8-plug, M12-bushing, open end



As standard, we offer the listed products for self-soldering.
The contact assignment of the pre-assembled connections can be found in the following data sheets.

Ordering example: G-SEK100-O/U-1FE12
G-MEK063-O/U-6PM5-1E12

FEB12	
Electric strip, female	
12-poles (female)	
Strip 2x 6 rows	
Rated current per pole: 2A	
Contact resistance < 20mΩ	
Contact spacing: 2,54mm	
Gilded	
Solder connection	

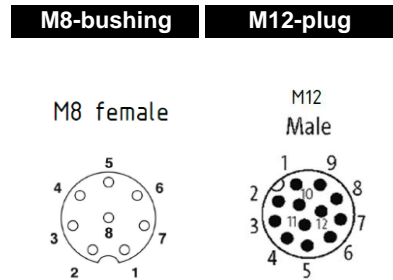
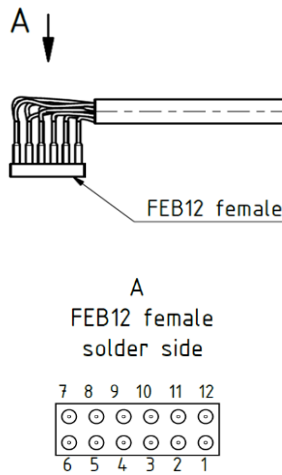

300-M8
300mm cable, circular connector M8-bushing



pin assignment	
1	white
2	brown
3	green
4	yellow
5	grey
6	pink
7	blue
8	red
9	---
10	---
11	---
12	---

M8-bushing
8 poles (female)
Cable: drag chain suitable
According to IEC-61076-2-104
Operating voltage: max 30 V
Rated current (at 30°): 1,5 A
Temperature range: -25...85°C
Cable: PUR halogen-free

included in: G-SEK100-O-1FE12-300-M8
G-MEK063-O-4PR4-1FE12-300-M8

spare part: EG-MEK-FEB12-300-M8-BW

300-M12
300mm cable, circular connector M12 plug

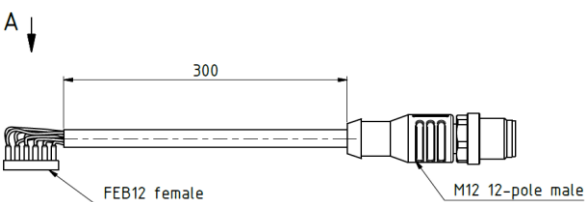

FEB12 female	colour	M12 male
1	white	3
2	brown	1
3	green	4
4	yellow	6
5	grey	8
6	pink	5
7	blue	2
8	red	9
9	black	7
10	violet	10
11	grey/pink	11
12	blue/red	12

M12-plug
12 poles (male)
Cable: drag chain suitable
12 x 0,14mm ² , Ø5,6
According to IEC-61076-2-104
Operating voltage: max 30 V
Rated current (at 30°): 1,5 A
Insulation resistance: ≥10 ³ Ω
Temperature range: -25...85°C
Cable: PUR halogen-free

included in: G-SEK100-O-1FE12-300-M12
G-MEK063-O-4PR4-1FE12-300-M12

spare part: EG-MEK-FEB12-300-M12

2000-OE
2000mm cable, open end

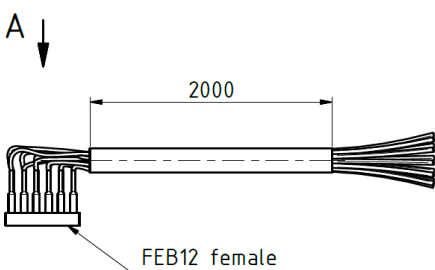

pin assignment	
1	white
2	brown
3	green
4	yellow
5	grey
6	pink
7	blue
8	red
9	black
10	violet
11	grey-pink
12	blue-red

Open end
12 poles
Cable: drag chain suitable
Outer-Ø (D): 5,6 ± 0,2mm
Nominal voltage: ≤300V
Bending radius:
- fixed installation: >5 x D
- in motion: >10 x D
Wire cross-section: 12 x 0,14mm ²
Insulation resistance: ≥10 ³ Ω
Temperature range: -25...85°C
Material: PUR halogen-free
Rated current (at 30°): 2 A

included in: G-SEK100-O-1FE12-2000-OE
G-MEK063-O-4PR4-1FE12-2000-OE

spare part: EG-MEK-FEB12-2000OE

FES12
Electric strip, male
Spring contacts
12 poles (male)
Strip 2x 6 rows
Spring force: 0,6N at 0,7mm
Rated current per pole: 2A
Contact resistance < 20mΩ
Contact spacing: 2,54mm
Gilded
Solder connection
Max stroke: 2,4mm

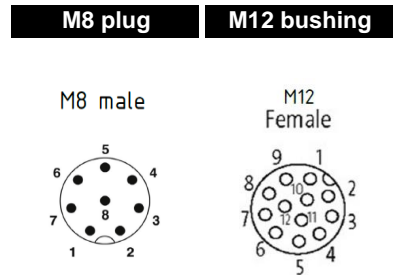

40-M8
40mm cable, circular connector M8 plug

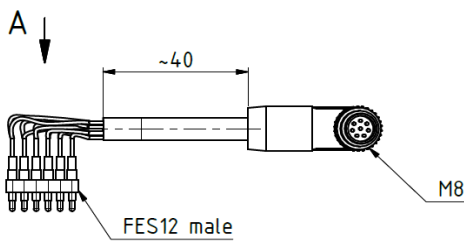

pin assignment	
1	white
2	brown
3	green
4	yellow
5	grey
6	pink
7	blue
8	red
9	---
10	---
11	---
12	---

M8 plug
8 poles (male)
Cable: drag chain suitable
Operating voltage: max 30 V
Rated current (at 30°): 1,5 A
Temperature range: -25...85°C
Cable: PUR halogen-free

included in: G-SEK100-U-1FE12-40-M8
G-MEK063-U-4PR4-1FE12-40-M8

spare part: EG-MEK-FES12-40-M8-SW

300-M12
300mm cable, circular connector M12 bushing

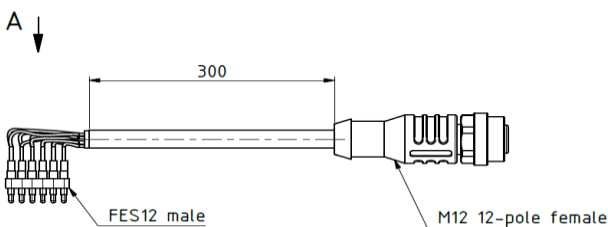

FES12 male	colour	M12 fem.
1	white	3
2	brown	1
3	green	4
4	yellow	6
5	grey	8
6	pink	5
7	blue	2
8	red	9
9	black	7
10	violet	10
11	grey/pink	11
12	blue/red	12

M12 bushing
12 poles (female)
Cable: drag chain suitable
12 x 0,14mm ² , Ø5,6
According to IEC-61076-2-104
Operating voltage: max 30 V
Rated current (at 30°): 1,5 A
Insulation resistance: ≥10 ³ Ω
Temperature range: -25...85°C
Cable: PUR halogen-free

included in: G-SEK100-U-1FE12-300-M12
G-MEK063-U-4PR4-1FE12-300-M12

spare part: EG-MEK-FES12-300-M12

2000-OE
2000mm cable, open end

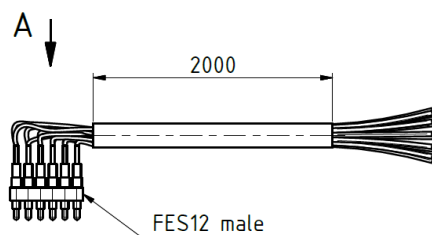

pin assignment	
1	white
2	brown
3	green
4	yellow
5	grey
6	pink
7	blue
8	red
9	black
10	violet
11	grey-pink
12	blue-red

Open end
12 poles
Cable: drag chain suitable
Outer-Ø (D): 5,6 ± 0,2mm
Nominal voltage: ≤300V
Bending radius:
- fixed installation: >5 x D
- in motion: >10 x D
Wire cross-section: 12 x 0,14mm ²
Insulation resistance: ≥10 ³ Ω
Temperature range: -25...85°C
Material: PUR halogen-free
Rated current (at 30°): 2 A

included in: G-SEK100-U-1FE12-2000-OE
G-MEK063-U-4PR4-1FE12-2000-OE
spare part: EG-MEK-FES12-2000OE

IKS12

- Insulating body with pins
- 12 poles (male)
- Rated current per pole: 9A
- Contact resistance < 3mΩ

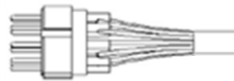

M8 bushing

M12 plug

M8 female

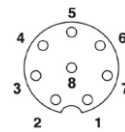

M12 Male

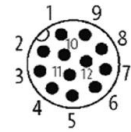

300-M8

300mm cable, circular connector M8 bushing

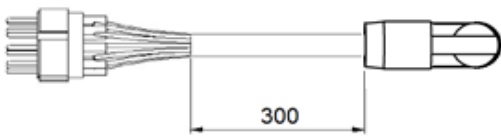

pin assignment	
1	white
2	brown
3	green
4	yellow
5	grey
6	pink
7	blue
8	red
9	---
10	---
11	---
12	---

M8 bushing

- 8 poles (female)
- Cable: drag chain suitable
- According to IEC-61076-2-104
- Operating voltage: max 30 V
- Rated current (at 30°): 1,5 A
- Temperature range: -25...85°C
- Cable: PUR halogen-free

included in: G-SEK100-O-1E12-300-M8
G-MEK063-O-6PM5-1E12-300-M8

spare part: EG-MEK-IKS12-300-M8-BW

300-M12

300mm cable, circular connector M12 plug

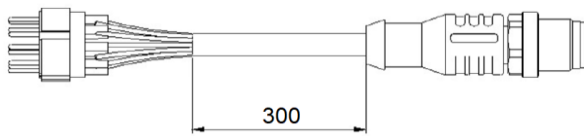

pin assignment	
1	brown
2	blue
3	white
4	green
5	pink
6	yellow
7	black
8	grey
9	red
10	violet
11	grey-pink
12	blue-red

M12 plug

- 12 poles (male)
- Cable: drag chain suitable
- 12 x 0,14mm², Ø5,6
- According to IEC-61076-2-104
- Operating voltage: max 30 V
- Rated current (at 30°): 1,5 A
- Insulation resistance: ≥10³Ω
- Temperature range: -25...85°C
- Cable: PUR halogen-free

included in: G-SEK100-O-1E12-300-M12
G-MEK063-O-6PM5-1E12-300-M12

spare part: EG-MEK-IKS12-300-M12

2000-OE

2000mm cable, open end



pin assignment	
1	brown
2	blue
3	white
4	green
5	pink
6	yellow
7	black
8	grey
9	red
10	violet
11	grey-pink
12	blue-red

Open end

- 12 poles
- Cable: drag chain suitable
- Outer-Ø (D): 5,6 ± 0,2mm
- Nominal voltage: ≤300V
- Bending radius:
 - fixed installation: >5 x D
 - in motion: >10 x D
- Wire cross-section: 12 x 0,14mm²
- Insulation resistance: ≥10³Ω
- Temperature range: -25...85°C
- Material: PUR halogen-free
- Rated current (at 30°): 2 A

included in: G-SEK100-O-1E12-2000-OE
G-MEK063-O-6PM5-1E12-2000-OE
spare part: EG-MEK-IKS12-2000-OE

IKB12

- Insulating body with bushings
- 12 poles (female)
- Rated current per pole: 9A
- Contact resistance < 3mΩ

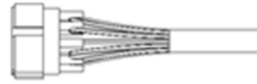

M8 plug

M12 bushing

M8 male

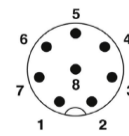

M12 Female

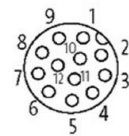

40-M8

40mm cable, circular connector M8 plug

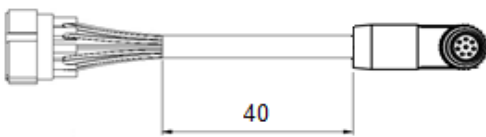

pin assignment	
1	white
2	brown
3	green
4	yellow
5	grey
6	pink
7	blue
8	red
9	---
10	---
11	---
12	---

M8 plug

- 8 poles (male)
- Cable: drag chain suitable
- Operating voltage: max 30 V
- Rated current (at 30°): 1,5 A
- Temperature range: -25...85°C
- Cable: PUR halogen-free

included in: G-SEK100-U-1E12-40-M8
G-MEK063-U-6PM5-1E12-40-M8

spare part: EG-MEK-IKB12-40-M8-SW

300-M12

300mm cable, circular connector M12 bushing

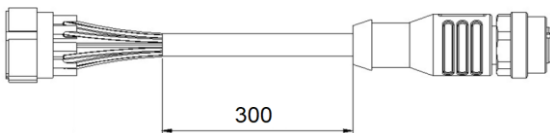

pin assignment	
1	brown
2	blue
3	white
4	green
5	pink
6	yellow
7	black
8	grey
9	red
10	violet
11	grey-pink
12	blue-red

M12 bushing

- 12 poles (female)
- Cable: drag chain suitable
- 12 x 0,14mm², Ø5,6
- According to IEC-61076-2-104
- Operating voltage: max 30 V
- Rated current (at 30°): 1,5 A
- Insulation resistance: ≥10³Ω
- Temperature range: -25...85°C
- Cable: PUR halogen-free

included in: G-SEK100-U-1E12-300-M12
G-MEK063-U-6PM5-1E12-300-M12

spare part: EG-MEK-IKB12-300-M12

2000-OE

2000mm cable, open end

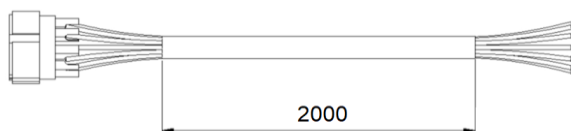

pin assignment	
1	brown
2	blue
3	white
4	green
5	pink
6	yellow
7	black
8	grey
9	red
10	violet
11	grey-pink
12	blue-red

Open end

- 12 poles
- Cable: drag chain suitable
- Outer-Ø (D): 5,6 ± 0,2mm
- Nominal voltage: ≤300V
- Bending radius:
 - fixed installation: >5 x D
 - in motion: >10 x D
- Wire cross-section: 12 x 0,14mm²
- Insulation resistance: ≥10³Ω
- Temperature range: -25...85°C
- Material: PUR halogen-free
- Rated current (at 30°): 2 A

included in: G-SEK100-U-1E12-2000-OE
G-MEK063-U-6PM5-1E12-2000-OE
spare part: EG-MEK-IKB12-2000-OE