

(1 : 2)

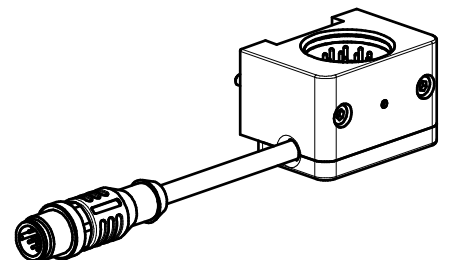

Datum 11.11.2016

Maßstab 1:1

Zeichnungsnummer

G-SEK125-0-1E12-300-M12

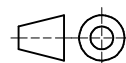

GRIP
GRIP GmbH Handhabungstechnik

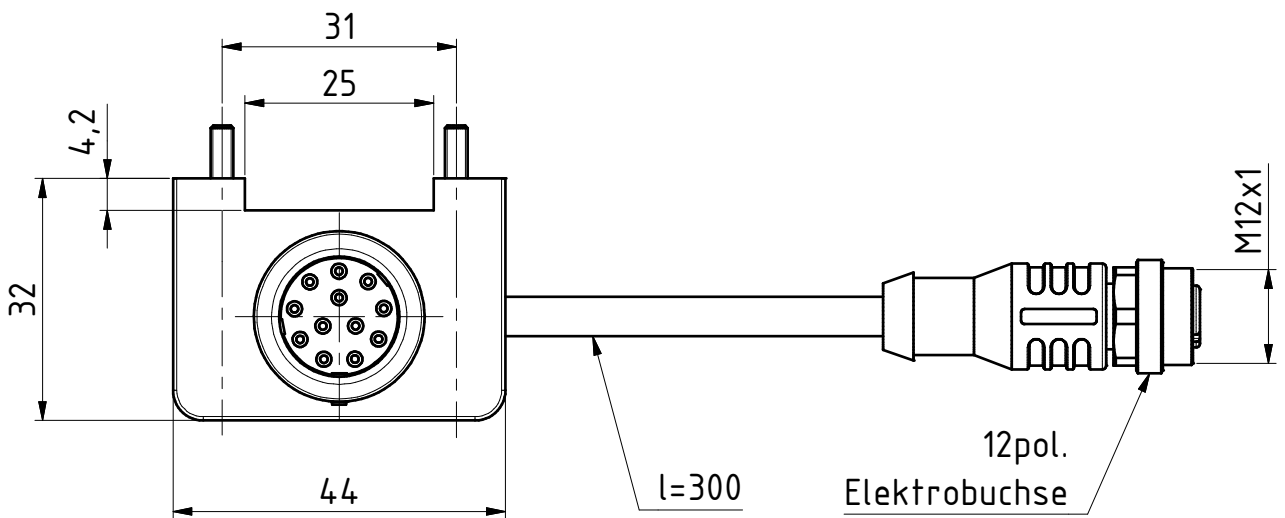
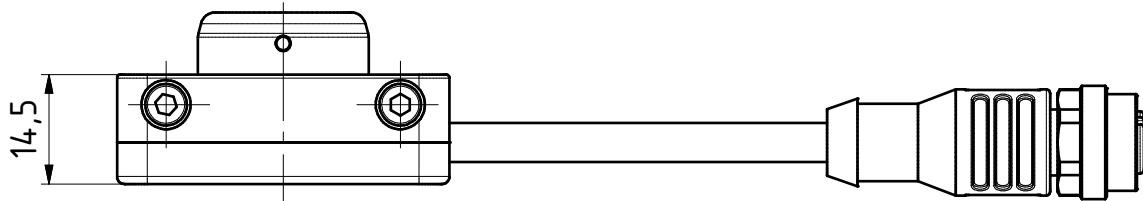
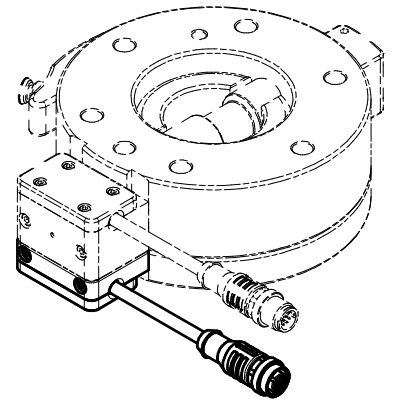

(1 : 2)

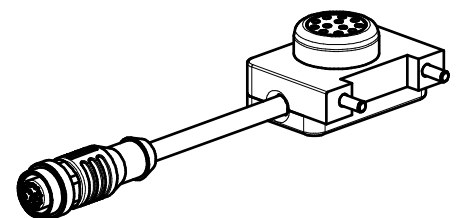

Datum 11.11.2016

Maßstab 1:1

Zeichnungsnummer

G-SEK125-U-1E12-300-M12

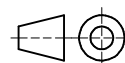

GRIP
GRIP GmbH Handhabungstechnik